

Fixtures intended for track system.
They allow creation of interesting lighting solutions with the possibility of directional changes.
The fixtures are designed for lighting in retail sector, shop windows, museums, art galleries, expositions and local authority buildings.

1. Architectural indoor lighting

1.1. Projector fixtures for single phase tracks TREX

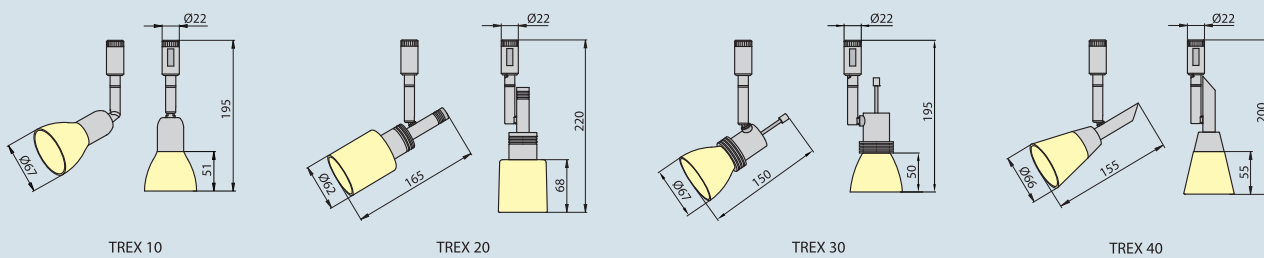

Material: handle – steel
cover – glass
adaptor – plastic

Fixtures suitable for single phase track TREX



TREX 10 Movable track fixture

Art. no.	Model	Index	Colour
0108	TREX 10	OT-TR1073-13	silver/milky cover

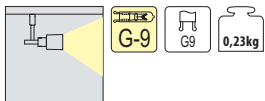

TREX 20 Movable track fixture

Art. no.	Model	Index	Colour
0109	TREX 20	OT-TR2073-13	silver/milky cover

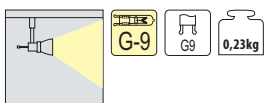

TREX 30 Movable track fixture

Art. no.	Model	Index	Colour
0110	TREX 30	OT-TR3073-13	silver/milky cover

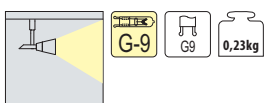

TREX 40 Movable track fixture

Art. no.	Model	Index	Colour
0111	TREX 40	OT-TR4073-13	silver/milky cover

1. Architectural indoor lighting

1.1. Projector fixtures for single phase tracks TREX

Material: reflector – TREX 60 – steel
 handle – steel
 cover – TREX 50 – glass
 adaptor – plastic

Fixtures suitable for single phase track TREX

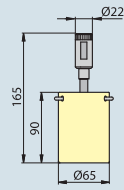

TREX 50

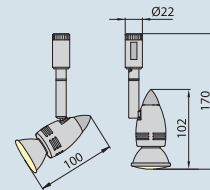

TREX 60

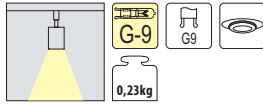
**TREX 50** Movable track fixture

Art. no.	Model	Index	Colour
0112	TREX 50	OT-TR5073-13	silver/milky cover

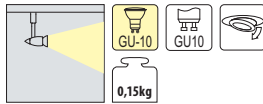
**TREX 60** Movable track fixture

Art. no.	Model	Index	Colour
0113	TREX 60	OT-TR6000-73	silver

1. Architectural indoor lighting

1.1. Elements of track system TREX

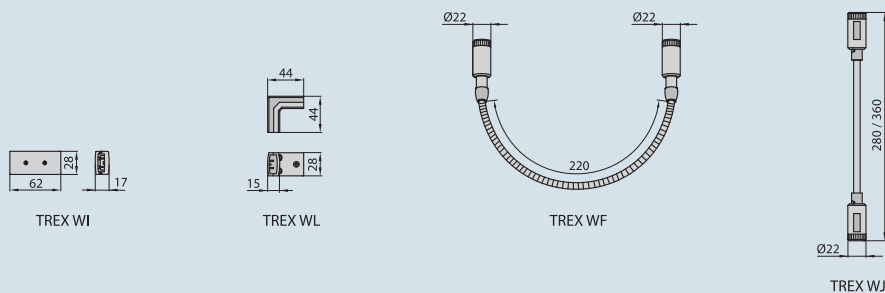

Material: body – TREX WI/WL – plastic; TREX WF/WJ – steel
adaptor – TREX WF/WJ – plastic

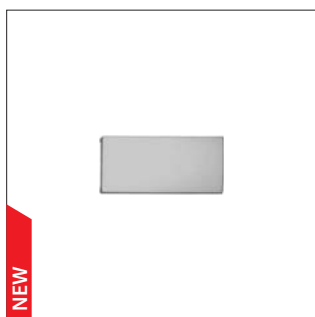

20g

TREX WI Connector

Art. no.	Model	Index	Colour
0114	TREX WI	ST-TRWI00-73	silver



20g

TREX WL Connector

Art. no.	Model	Index	Colour
0115	TREX WL	ST-TRWL00-73	silver



120g

TREX WF Flexible connector

Art. no.	Model	Index	Colour
0116	TREX WF	ST-TRWF00-73	silver



45g 280mm
50g 360mm

TREX WJ Connector

Art. no.	Model	Index	Lenght	Colour
0117	TREX WJ	ST-TRWJ15-73	280mm	silver
0118	TREX WJ	ST-TRWJ23-73	360mm	silver

Material: body – steel
adaptor – plastic

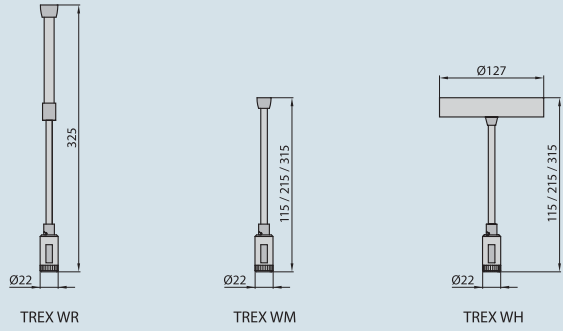

75g

TREX WR Telescopic hanger

Art. no.	Model	Index	Colour
0119	TREX WR	ST-TRWR00-73	silver



- 40g 115mm
- 50g 215mm
- 75g 315mm

TREX WM Hanger

Art. no.	Model	Index	Lenght	Colour
0120	TREX WM	ST-TRWM12-73	115mm	silver
0121	TREX WM	ST-TRWM20-73	215mm	silver
0122	TREX WM	ST-TRWM30-73	315mm	silver



- 230g 115mm
- 250g 215mm
- 280g 315mm

TREX WH Power connector

Art. no.	Model	Index	Lenght	Colour
0123	TREX WH	ST-TRWH12-73	115mm	silver
0124	TREX WH	ST-TRWH20-73	215mm	silver
0125	TREX WH	ST-TRWH30-73	315mm	silver

Material: body – TREX WE – plastic
 TREX TS – aluminium profile
 conductor – cooper
Track type: single phase

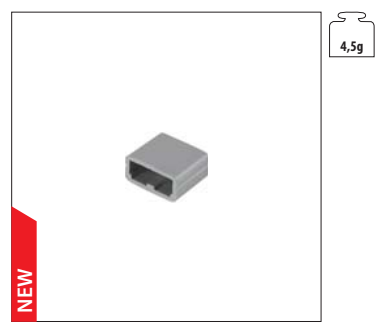
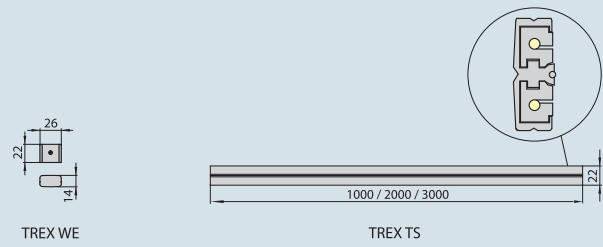

TREX WE End cap

Art. no.	Model	Index	Colour
0126	TREX WE	ST-TRWE00-73	silver

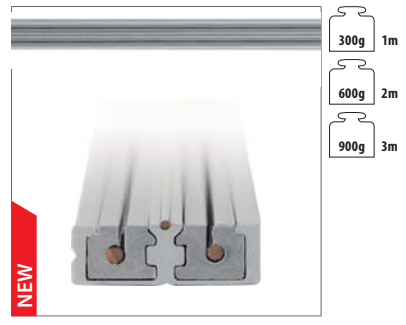

TREX TS Track

Art. no.	Model	Index	Lenght	Colour
0127	TREX TS	ST-TRTS10-73	1m	silver
0128	TREX TS	ST-TRTS20-73	2m	silver
0129	TREX TS	ST-TRTS30-73	3m	silver